



Cambridge IGCSE™ (9–1)

CANDIDATE
NAME

CENTRE
NUMBER

--	--	--	--	--

CANDIDATE
NUMBER

--	--	--	--



CO-ORDINATED SCIENCES

0973/41

Paper 4 Theory (Extended)

October/November 2021

2 hours

You must answer on the question paper.

No additional materials are needed.

INSTRUCTIONS

- Answer **all** questions.
- Use a black or dark blue pen. You may use an HB pencil for any diagrams or graphs.
- Write your name, centre number and candidate number in the boxes at the top of the page.
- Write your answer to each question in the space provided.
- Do **not** use an erasable pen or correction fluid.
- Do **not** write on any bar codes.
- You may use a calculator.
- You should show all your working and use appropriate units.

INFORMATION

- The total mark for this paper is 120.
- The number of marks for each question or part question is shown in brackets [].
- The Periodic Table is printed in the question paper.

This document has **28** pages. Any blank pages are indicated.

1 (a) Fig. 1.1 is a diagram of the gas exchange system in humans.

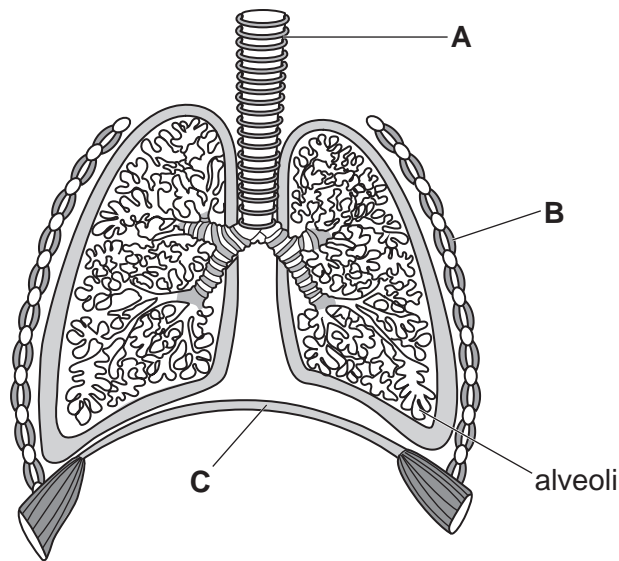

Fig. 1.1

(i) Identify the parts labelled **A**, **B** and **C** in Fig. 1.1.

- A
- B
- C [3]

(ii) The alveoli are the gas exchange surface in humans.

State **two** features of alveoli that make them efficient gas exchange surfaces.

- 1
- 2 [2]

- (b) Two similar sized groups of people are monitored. One group smoke tobacco (smokers) and the other group do not (non-smokers).

The number of smokers and non-smokers of different ages with chronic obstructive pulmonary disease (COPD) are recorded. Fig. 1.2 shows the results.

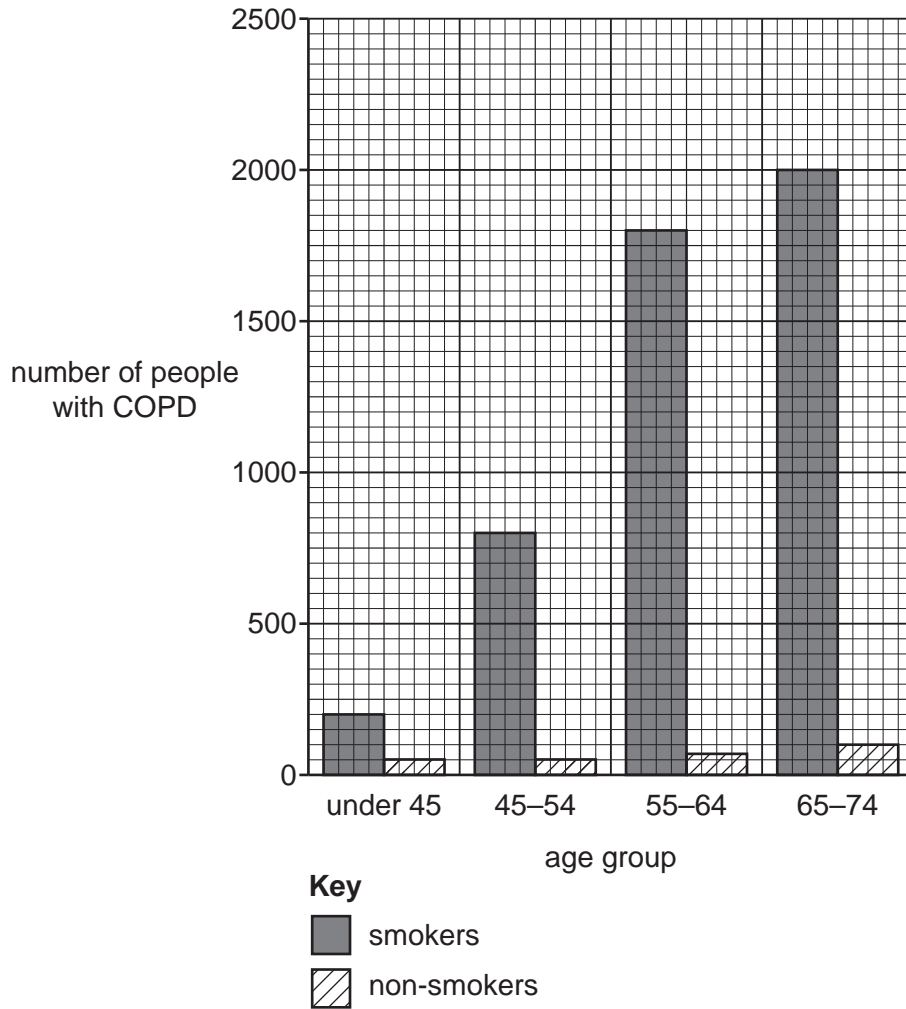

Fig. 1.2

Describe the results shown in Fig. 1.2.

.....

.....

.....

.....

.....

.....

..... [3]

(c) The tar in tobacco smoke stops the ciliated cells in the gas exchange system from working efficiently.

(i) Explain how this would increase the likelihood of infection in the lungs.

Include ideas about goblet cells in your answer.

.....
.....
.....
.....
.....
..... [3]

(ii) Name the substance in tobacco smoke that is addictive.

..... [1]

[Total: 12]

2 Ammonia, NH₃, is made in the Haber process.

The balanced symbol equation is shown.

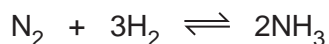

Fig. 2.1 shows how ammonia is made.

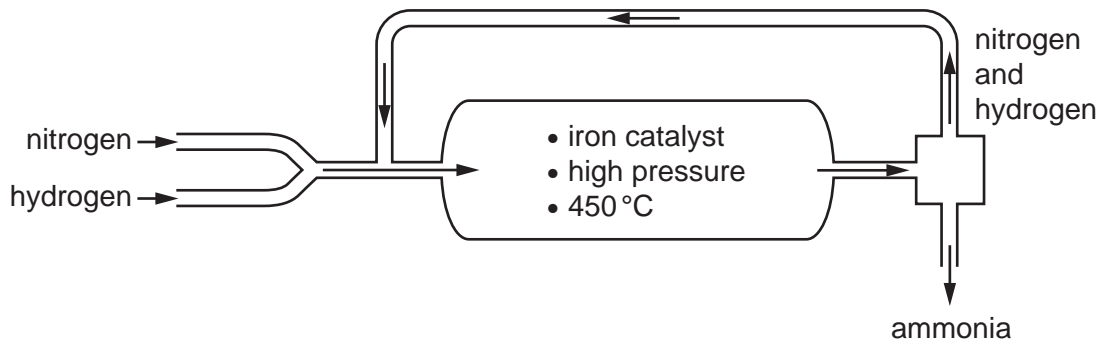

Fig. 2.1

(a) The reaction between nitrogen and hydrogen is a reversible reaction.

State what is meant by a reversible reaction.

..... [1]

(b) Describe what happens to unreacted nitrogen and hydrogen.

..... [1]

(c) It is important to make ammonia as cheaply as possible.

The conditions used to make ammonia are an iron catalyst, a high pressure and a temperature of 450 °C.

Two of the factors that affect cost are:

- the percentage of ammonia made
- the rate of reaction.

Explain why each condition is used.

Use ideas about percentage of ammonia made and the rate of reaction.

iron catalyst

.....

high pressure

.....

450 °C

..... [3]

7

(d) The atoms in a molecule of nitrogen, N_2 , are held together by covalent bonds.

The electronic structure of nitrogen is 2,5.

Draw the dot-and-cross diagram to show the bonding in nitrogen.

You only need to include the outer shell electrons.

[2]

(e) Ammonia reacts with sulfuric acid.

The balanced symbol equation is shown.

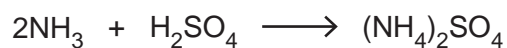

Calculate the mass of sulfuric acid, H_2SO_4 , needed to react completely with 68 g of ammonia.

Show your working.

[A_r : H, 1; N, 14; O, 16; S, 32]

mass of sulfuric acid = g [3]

[Total: 10]

- 3 (a) State the speed of electromagnetic waves in a vacuum.

..... [1]

- (b) Fig. 3.1 shows an incomplete electromagnetic spectrum.

- (i) Write visible light in its correct position in the spectrum. [1]

		ultraviolet		infrared	microwaves	
--	--	-------------	--	----------	------------	--

Fig. 3.1

- (ii) State the form of electromagnetic radiation that has the highest frequency.

..... [1]

- (c) Visible light is an example of a transverse wave.

- (i) Use a double headed arrow (\leftrightarrow or \updownarrow) to label the wavelength of the transverse wave shown in Fig. 3.2. [1]

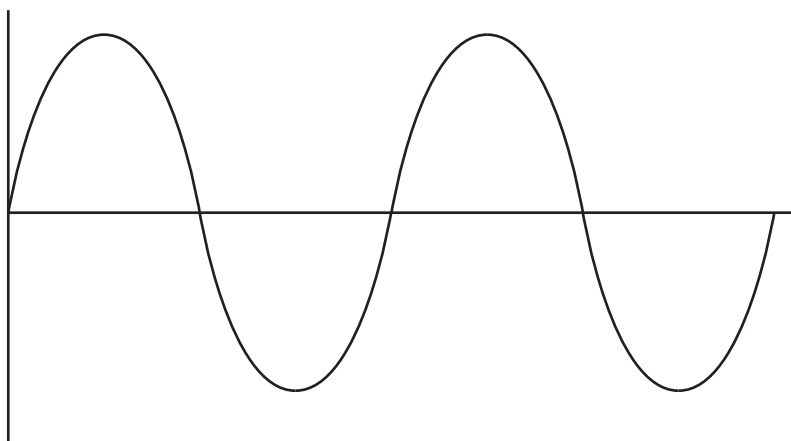

Fig. 3.2

- (ii) State the equation that links the frequency, speed and wavelength of a wave.

..... [1]

(d) Fig. 3.3 shows an object placed close to a thin converging lens.

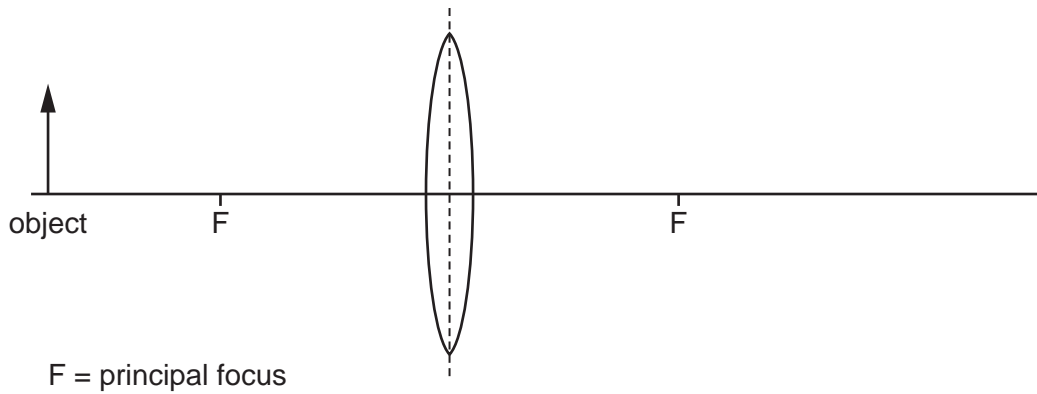

Fig. 3.3

(i) Complete Fig. 3.3 to show how the rays of light from the object form an image. [3]

(ii) The image formed by this lens is real.

State what is meant by a *real image*.

.....
 [1]

(iii) Suggest a use for a thin converging lens such as the one shown in Fig. 3.3.

.....
 [1]

[Total: 10]

- 4 (a) Antibiotics are drugs that are used to kill bacteria.

A scientist investigates antibiotic resistance in bacteria. The scientist uses four different antibiotics discs **A**, **B**, **C** and **D**.

The results are shown in Fig. 4.1.

The white areas show where no bacteria have grown.

The dark areas show where bacteria have grown.

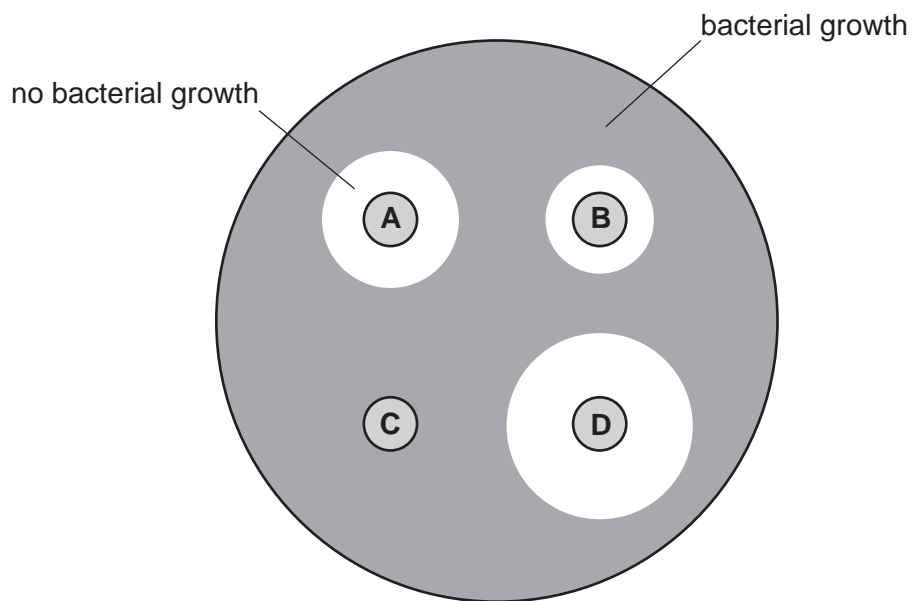

Fig. 4.1

- (i) Identify the antibiotic that is most effective against the bacteria.

..... [1]

- (ii) Identify the antibiotic that the bacteria are most resistant to.

..... [1]

(b) The development of antibiotic resistance is an example of evolution by natural selection.

(i) Complete the sentences to describe how strains of bacteria with antibiotic resistance develop.

A mutation occurs which causes a change in the

This mutation causes some bacteria to be resistant to antibiotics.

Antibiotics kill non-resistant bacteria.

Resistant bacteria survive and

The for resistance is passed on to their offspring.

Eventually all the population of bacteria will be resistant to antibiotics. [3]

(ii) Describe **one** way natural selection is different from artificial selection.

.....

..... [1]

(c) Bacteria reproduce by a type of asexual reproduction.

State **one** advantage and **one** disadvantage of asexual reproduction.

advantage

.....

disadvantage

..... [2]

[Total: 8]

5 Magnesium carbonate, MgCO_3 , reacts with dilute hydrochloric acid, HCl .

Magnesium chloride, MgCl_2 , carbon dioxide and water are made.

(a) Write the balanced symbol equation for this reaction.

..... [2]

(b) A student investigates the reaction between magnesium carbonate and dilute hydrochloric acid.

Fig. 5.1 shows the apparatus used.

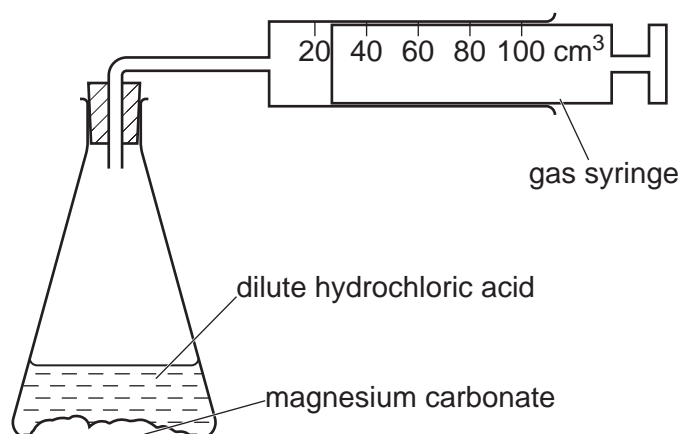

Fig. 5.1

The student measures the total volume of carbon dioxide gas collected every 10 seconds.

The student then repeats the experiment using the same amount of magnesium carbonate and the same volume of hydrochloric acid.

The hydrochloric acid is more concentrated.

In both experiments all of the magnesium carbonate is used up by the end of the reaction.

Table 5.1 shows the student's results.

Table 5.1

time/seconds		0	10	20	30	40	50	60	70	80
volume of carbon dioxide in cm^3	dilute hydrochloric acid	0	12	25	33	40	43	46	48	48
	concentrated hydrochloric acid	0	25	38	44	46	48	48	48	48

13

- (i) Look at the results for the **dilute** acid in Table 5.1.

State how long it takes to make 33 cm^3 of carbon dioxide gas.

time = seconds [1]

- (ii) Look at the results for **both** experiments in Table 5.1.

The total volume of carbon dioxide gas is the same at the end of both experiments.

Explain why.

..... [1]

- (iii) Describe the test for carbon dioxide gas and its positive result.

test

result [2]

- (iv) The volume of carbon dioxide gas made in both experiments is 48 cm^3 .

Calculate the mass of 48 cm^3 of carbon dioxide gas.

The molar gas volume at 25°C is 24 dm^3 .

Show your working.

[A_r : C, 12; O, 16]

mass of carbon dioxide gas = g [3]

- (c) Describe and explain the effect of increasing the concentration on the rate of reaction.

Explain your answer in terms of collisions between particles.

.....

 [3]

[Total: 12]

- 6 Some students are investigating moments and turning effects. Fig. 6.1 shows a beam of uniform density in equilibrium. The beam has a mass of 20 g on one end and a stone on the other.

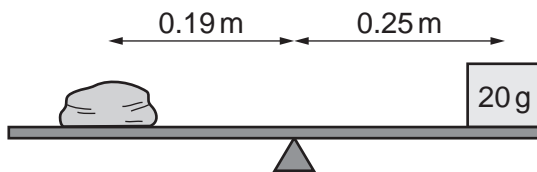

Fig. 6.1

- (a) State the meaning of the word equilibrium.

.....
 [1]

- (b) (i) Calculate the weight of the 20 g mass.
 gravitational field strength $g = 10 \text{ N/kg}$

weight = N [3]

- (ii) Calculate the mass of the stone.

State the unit for your answer.

mass = unit [4]

- (c) Describe a method for determining the volume of an irregular object like the stone.

.....

 [2]

[Total: 10]

BLANK PAGE

7 (a) Fig. 7.1 is a diagram of a villus.

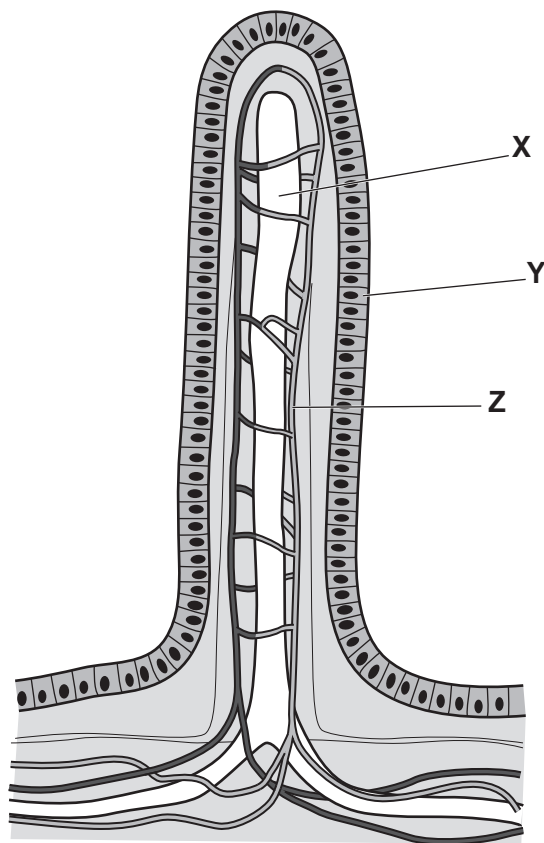

Fig. 7.1

(i) Table 7.1 shows some of the names, functions and letters in Fig. 7.1 of parts of a villus. Complete Table 7.1.

Table 7.1

name	letter in Fig. 7.1	function
		absorption of fats
epithelial cell		contain microvilli
		transport of nutrients around the body

[3]

(ii) Describe how villi aid the process of digestion.

.....

.....

.....

.....

[2]

(b) Fig. 7.2 is a diagram of the alimentary canal and associated organs.

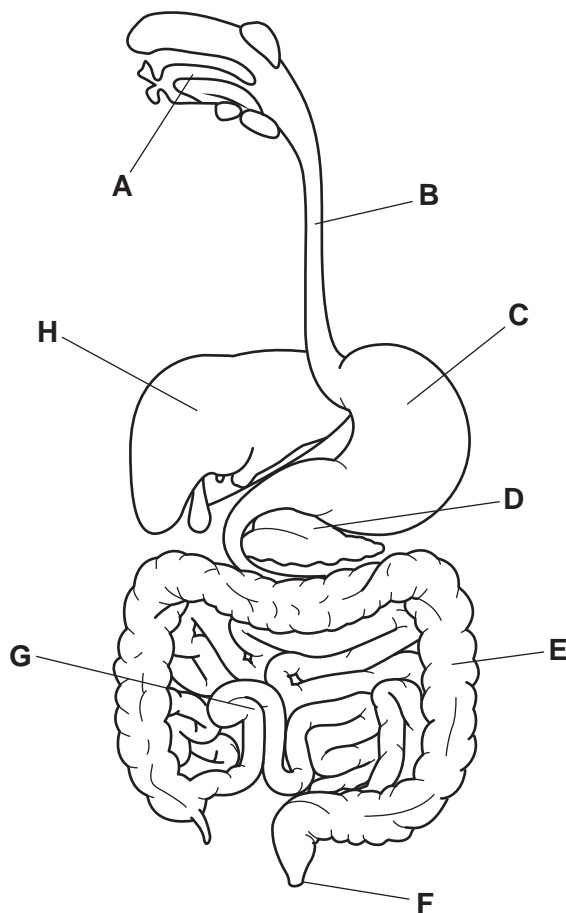

Fig. 7.2

(i) Identify the letter on Fig. 7.2 that represents:

where egestion occurs

where bile is produced

where dental decay can occur.

[3]

(ii) State the name of the type of organism that causes dental decay.

..... [1]

(c) Bile is mixed with gastric juice when they enter the small intestine.

Describe the effect of bile on the pH of the gastric juice.

.....
 [1]

[Total: 10]

- 8 Fig. 8.1 shows the apparatus that is used to electrolyse concentrated aqueous sodium chloride.

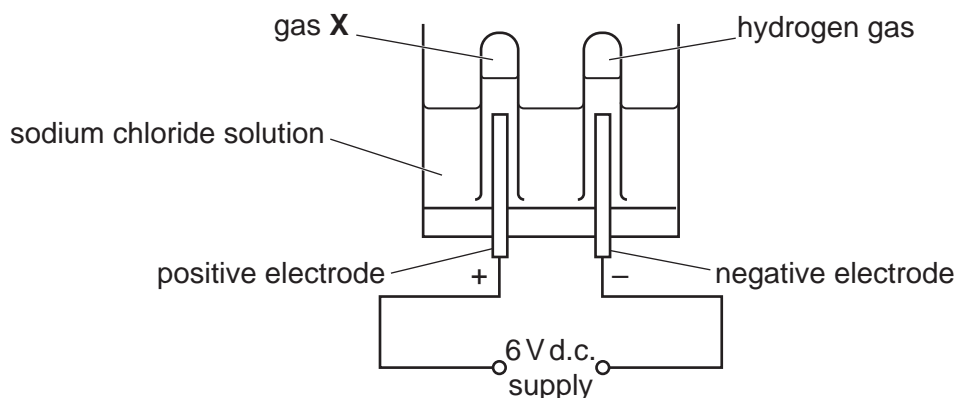

Fig. 8.1

- (a) (i) Hydrogen gas is made at the negative electrode.
State the name of the negative electrode.
..... [1]
- (ii) State the name of the pale green gas X, formed at the positive electrode.
..... [1]
- (iii) During the electrolysis, sodium hydroxide solution forms in the apparatus.
Sodium hydroxide solution is an alkali.
Describe a simple test and its positive result to show that sodium hydroxide is an alkali.
test
result [2]
- (b) Construct the ionic half-equation for the formation of hydrogen gas, H_2 , at the negative electrode.
Use e^- to represent an electron.
..... [2]

19

- (c) Hydrogen gas, H_2 , has a boiling point of $-253\text{ }^\circ\text{C}$.
Sodium chloride, NaCl , has a boiling point of $1465\text{ }^\circ\text{C}$.

Explain the difference in these boiling points in terms of attractive forces.

.....

.....

.....

..... [3]

[Total: 9]

- 9 Fig. 9.1 shows a person sitting in an inflatable raft.

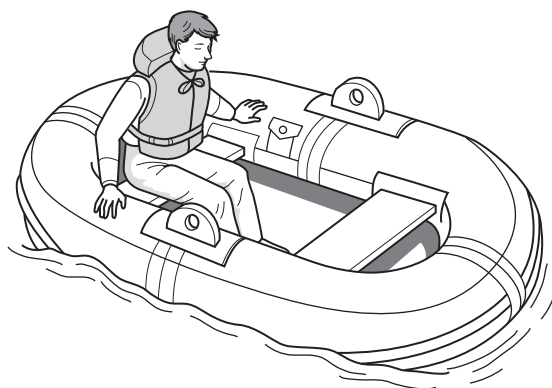

Fig. 9.1

- (a) The raft consists of a large rubber tube inflated with air.

- (i) Describe how the motion of the air molecules causes pressure inside the rubber tube.

.....
.....
.....
..... [2]

- (ii) As the sun warms up the air inside the rubber tube, the pressure increases.

Explain why the pressure increases.

.....
.....
.....
.....
..... [3]

(b) The combined weight of the raft and the person is 1100 N. The raft exerts a pressure of 500 Pa on the surface of the water.

(i) Calculate the area of raft in contact with the water.

area = m² [2]

(ii) The tide causes the raft to move at a speed of 4.0 m/s.
Calculate the kinetic energy of the raft and the person.
gravitational field strength $g = 10 \text{ N/kg}$

kinetic energy = J [3]

(iii) State what causes tides.

..... [1]

[Total: 11]

10 Hormones control blood glucose concentration.

(a) State the name of the part of the blood that transports hormones.

..... [1]

(b) Fig. 10.1 is a flowchart showing the control of blood glucose concentration.

Complete the flowchart in Fig. 10.1.

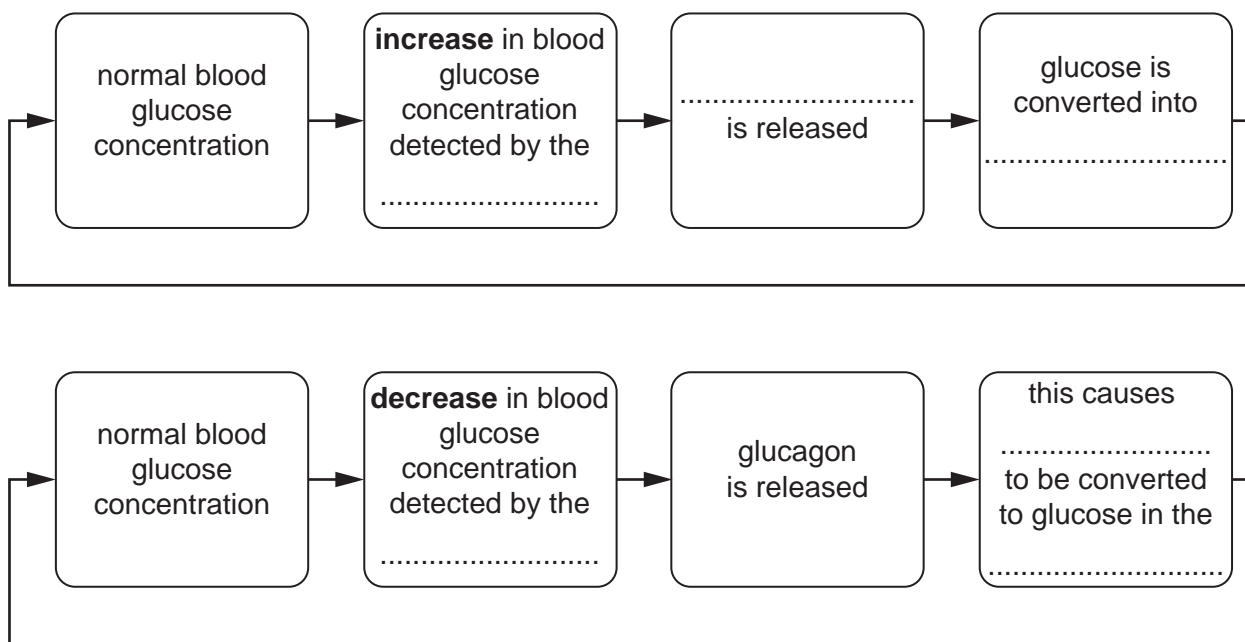

Fig. 10.1

[4]

(c) State the term that is used to describe this type of control.

..... [1]

(d) Name **one other** hormone that increases the glucose concentration of the blood.

..... [1]

(e) Table 10.1 compares nervous and hormonal control.

Complete Table 10.1.

Table 10.1

	hormonal control	nervous control
transmission method	in the blood	
speed of transmission		
length of effect		

[3]

[Total: 10]

- 11 (a) This is the information given on the Periodic Table about an atom of iron.

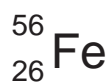

Complete Table 11.1 to show the numbers of protons and neutrons in this iron atom.

Table 11.1

particle	number
protons
neutrons
electrons	26

[2]

- (b) Iron metal corrodes.

Stainless steel is an alloy made from iron and chromium.

Describe **one** difference in the properties of the alloy stainless steel and the metal iron.

.....
 [1]

- (c) Iron pyrites is an ionic compound.

Fig. 11.1 shows a structure for iron pyrites.

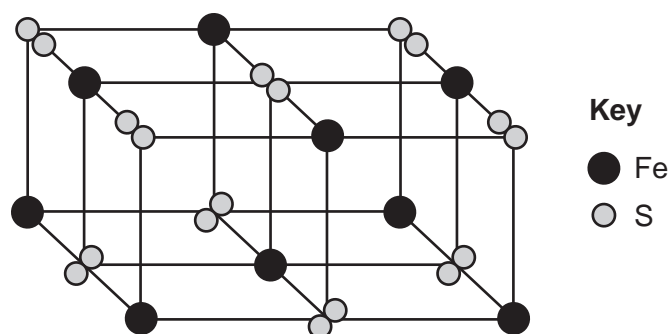

Fig. 11.1

Determine the **formula** of iron pyrites using Fig. 11.1.

formula = [1]

(d) Iron metal reacts with the non-metal oxygen to form iron oxide.

Iron oxide is an ionic compound.

Describe how metallic and non-metallic elements form ionic bonds.

.....

.....

.....

..... [3]

(e) Iron is extracted from iron oxide by reduction with carbon.

Explain why carbon can be used to extract iron from iron oxide.

.....

.....

..... [2]

[Total: 9]

12 Fig. 12.1 shows a transformer.

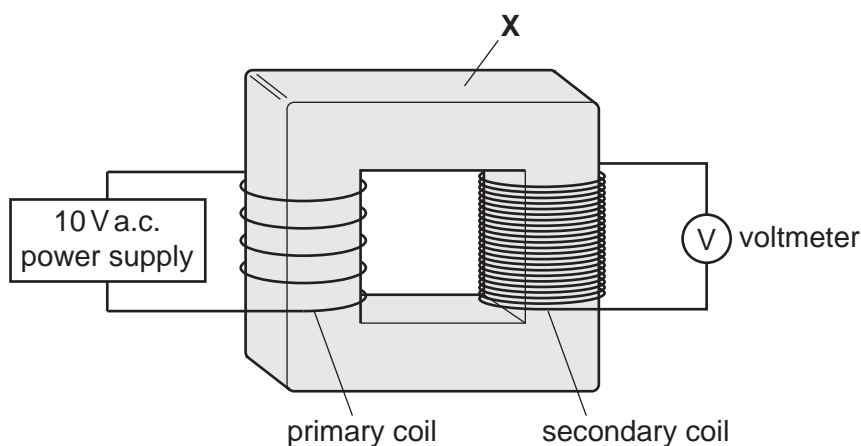

Fig. 12.1

- (a) (i) State the name of the component labelled X. [1]
 (ii) Suggest a suitable material for making component X.
 [1]
- (b) There are 5 turns on the primary coil and 30 on the secondary coil.
 (i) Calculate the reading on the voltmeter.

voltage =V [2]

- (ii) Suggest **two** ways to increase the reading on the voltmeter.
 1
 2 [2]

- (c) The following statements explain how the transformer produces a reading on the voltmeter. The statements are in the wrong order.
- A. An alternating potential difference is applied to the primary coil.
 - B. The secondary coil experiences a changing magnetic field.
 - C. This produces a changing magnetic field in the primary coil.
 - D. An alternating current flows in the primary coil.
 - E. This produces an alternating potential difference across the voltmeter.

Arrange the statements into the correct order. The first and last steps have been done for you.



[2]

(d) The transformer has an efficiency of 95%.
Describe what is meant by an efficiency of 95%.

.....
.....[1]

[Total: 9]

The Periodic Table of Elements

Group																	
I	II							III	IV	V	VI	VII	VIII				
3 Li lithium 7	4 Be beryllium 9	Key atomic number atomic symbol name relative atomic mass						5 B boron 11	6 C carbon 12	7 N nitrogen 14	8 O oxygen 16	9 F fluorine 19	10 Ne neon 20				
11 Na sodium 23	12 Mg magnesium 24							13 Al aluminium 27	14 Si silicon 28	15 P phosphorus 31	16 S sulfur 32	17 Cl chlorine 35.5	18 Ar argon 40				
19 K potassium 39	20 Ca calcium 40	21 Sc scandium 45	22 Ti titanium 48	23 V vanadium 51	24 Cr chromium 52	25 Mn manganese 55	26 Fe iron 56	27 Co cobalt 59	28 Ni nickel 59	29 Cu copper 64	30 Zn zinc 65	31 Ga gallium 70	32 Ge germanium 73	33 As arsenic 75	34 Se selenium 79	35 Br bromine 80	36 Kr krypton 84
37 Rb rubidium 85	38 Sr strontium 88	39 Y yttrium 89	40 Zr zirconium 91	41 Nb niobium 93	42 Mo molybdenum 96	43 Tc technetium —	44 Ru ruthenium 101	45 Rh rhodium 103	46 Pd palladium 106	47 Ag silver 108	48 Cd cadmium 112	49 In indium 115	50 Sn tin 119	51 Sb antimony 122	52 Te tellurium 128	53 I iodine 127	54 Xe xenon 131
55 Cs caesium 133	56 Ba barium 137	57–71 lanthanoids	72 Hf hafnium 178	73 Ta tantalum 181	74 W tungsten 184	75 Re rhenium 186	76 Os osmium 190	77 Ir iridium 192	78 Pt platinum 195	79 Au gold 197	80 Hg mercury 201	81 Tl thallium 204	82 Pb lead 207	83 Bi bismuth 209	84 Po polonium —	85 At astatine —	86 Rn radon —
87 Fr francium —	88 Ra radium —	89–103 actinoids	104 Rf rutherfordium —	105 Db dubnium —	106 Sg seaborgium —	107 Bh bohrium —	108 Hs hassium —	109 Mt meitnerium —	110 Ds darmstadtium —	111 Rg roentgenium —	112 Cn copernicium —	114 Fl flerovium —	116 Lv livermorium —	—	—	—	—

57 La lanthanum 139	58 Ce cerium 140	59 Pr praseodymium 141	60 Nd neodymium 144	61 Pm promethium —	62 Sm samarium 150	63 Eu europium 152	64 Gd gadolinium 157	65 Tb terbium 159	66 Dy dysprosium 163	67 Ho holmium 165	68 Er erbium 167	69 Tm thulium 169	70 Yb ytterbium 173	71 Lu lutetium 175
89 Ac actinium —	90 Th thorium 232	91 Pa protactinium 231	92 U uranium 238	93 Np neptunium —	94 Pu plutonium —	95 Am americium —	96 Cm curium —	97 Bk berkelium —	98 Cf californium —	99 Es einsteinium —	100 Fm fermium —	101 Md mendelevium —	102 No nobelium —	103 Lr lawrencium —

The volume of one mole of any gas is 24 dm³ at room temperature and pressure (r.t.p.).